

Route de Beaumont
F 60530 Fresnoy-en-Thelle
tél. : 33 (0)3.44.26.51.89
fax : 33 (0)3.44.26.90.79

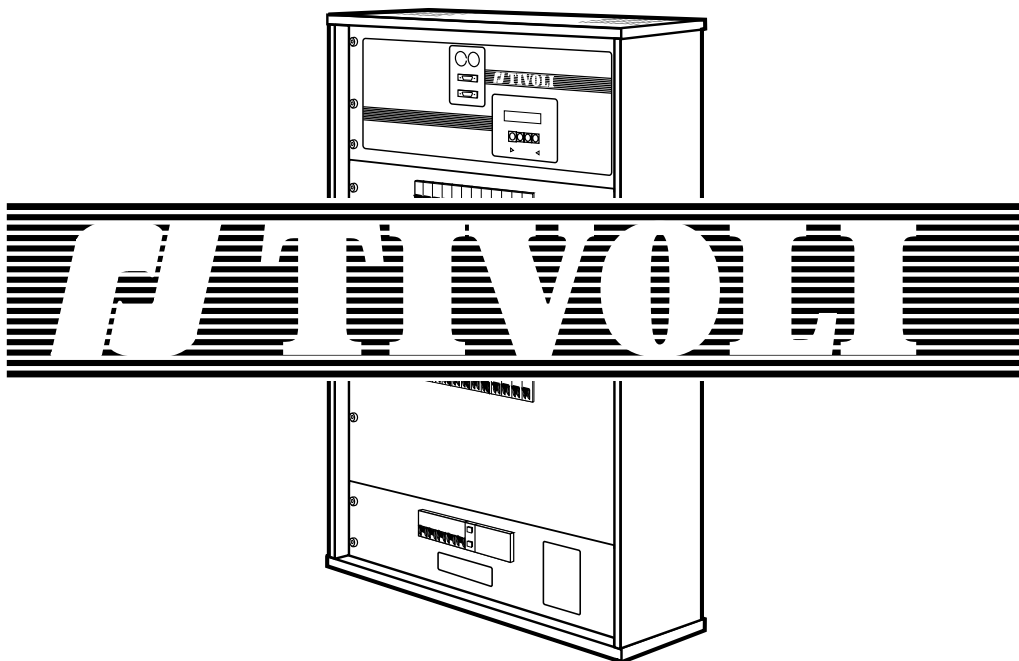

VERSION 1 - 02

**USITT DMX 512 ACCORDED
WIRING DATA**

1. PRESENTATION	4
1.1. INTRODUCTION TO THE TIVOLI CABINET	4
1.2. MANUAL ORGANISATION	4
1.3. LOGIC OF THE SYSTEM	5
1.4. START MENU	6
2. BASIC MENU	7
2.1. LEVELS	10
2.2. CONFIGURATION	11
2.3. CHANNEL TEST	13
2.4. PREFERENCES	13
2.5. INFORMATION	14
2.6. SOFTWARE RESET	15
2.7. FURTHER DETAILS	16
3. DIGI TYPE MENU	17
3.1. LEVELS	17
3.2. CHANNELS	17
3.3. CURVES	18
3.4. LOCAL CONTROL	18
3.5. RENAME	19
3.6. STAGE (CONFIG.)	19
3.7. CHANNEL TEST	19
3.8. PREFERENCES	20
3.9. INFORMATION	20

4. THE FULL MENU 21

4.1. LEVELS 21

4.2. CONFIGURATION 21

4.3. CHANNEL TEST 23

4.4. SHOW 23

4.4.1. MEMORIES 24

4.4.2. CROSSFADES 25

4.4.3. SHOW EXECUTION 27

4.4.4. SHOW PLUS MENU 28

4.4.5. SHOW PARAMETERS 28

4.4.6. MASTERS 29

4.4.7. INDEPENDENTLY-TIMED FADES 29

4.4.8. EXTERNAL SWITCHES 30

4.4.9. SHOW INFO 31

4.5. PREFERENCES 32

4.5.1. CHANNEL PREFERENCES 33

4.5.2. UNIT PREFERENCES 34

4.6. TEST & INFO 35

4.7. SOFTWARE RESET 36

5. APPENDIX 38

- Chart 256 steps DMX 38

- Data wiring 42

Note: This user's manual is meant for TIVOLI program versions 1-01 -> 1-09.

1. PRESENTATION

1.1. INTRODUCTION TO THE TIVOLI RACK

The TIVOLI rack is a completely digital dimmer unit, fitting up to 24 channels. It is the newcomer in the range of the ROBERT JULIAT digital dimmers.

TIVOLI checks the DMX 512 signal and rejects the data packets (or the end of data packets) which carry errors due to the transmission. When switching on the dimmer rack, and each time data is applied, TIVOLI analyses the protocol it receives before authorising the reception. Should the data link be cut off, TIVOLI will retain the last valid data frame and hold that output.

TIVOLI also accepts analog 0/+10V and local controls. The output level is determined by the highest input level, according to the dimmer curve and to the limitation imposed on each channel. The dimmer curve is the transposition of the input level to an output level following a specified lighting law. A 0 to 100% limitation proportionally limits the dimmer output.

TIVOLI is designed for either single-phase or three-phase A.C. Voltage. The input frequency range is 45.5Hz to 64Hz. A constant mains frequency is highly recommended. For further information on electric connection and the output power of the channels, please refer to the technical data sheet.

TIVOLI can also be configured using a number of parameters; it can receive internal-sequence controls and display information which facilitate optimum functioning. All these functions are performed by TIVOLI in addition to real time light control.

TIVOLI can work in "Automatic Mode", meaning it can execute sequences programmed into the unit. In this manner, it will allow you to enter memories which will be played back through a local or external control. Versatility and working convenience are achieved through memories link - sequences and independently-time fades.

A smoothing function improves dramatically the lighting yield by increasing the digital control resolution from 256 steps to 7,500 steps through interpolation. The smoothing function is active by default.

1.2. ORGANISATION OF THIS MANUAL

The TIVOLI user's manual is organised as follows: the first chapter (this one) is a general introduction to the cabinet (§1.1) with the description of the control panel - keys and LCD keyboard -, together with the description of the start menu. Please read the whole chapter with care.

The 2nd chapter gives a detailed description of the basic menu and accessibility to the mentioned displays. It also explains the required key presses. If you are a beginner, this chapter is a must.

The 3rd chapter contains the differences between the DIGI IV/Vs displays and the Digi box type menu. You are a regular user of the DIGI IV/Vs dimmers, then you will start directly from this chapter.

The 4th chapter is addressed to the users who wish to give a personal touch to their cabinet. This chapter gives the description of the possibilities and parameters of TIVOLI.

For the best use of the different possibilities of TIVOLI, it is highly recommended to operate the unit while reading this manual.

1.3. LOGIC OF THE SYSTEM

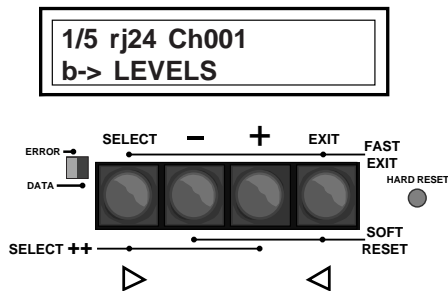

The front control panel of TIVOLI gives access to the different screens and items, and allows the display of messages. When the unit is switched on, or after a hardware reset, you will read on the screen the following (see picture on left):

First line: 1/5 shows a menu which admits 5 lines of options, from which the first one (1) is on display; rj24 shows the number of channels (24) fitting in the cabinet; finally, 001 is the N° of the first channel the unit will read out.

Second line: b shows the basic menu as the current menu and LEVELS as the current option.

The LCD shows several screens. Either these displays are menus which allow you to choose between several possibilities indicated on the LCD, or they are edit screens which show different parameters and allow their modification.



Using the keys SELECT, "+", "-" and EXIT, will allow you to 'navigate' through the available screens.



The 5th key, HARD RESET, carries out a restart of the card but does not erase the data which are stored in the memory. To avoid any casual operation, this key is partially concealed.



In the menus, the "+" and "-" keys allow you to scroll the options so that you can choose one via the SELECT key. In the edit screens, the SELECT and EXIT keys allow you to go forward or backward one 'field' while the "+" and "-" keys allow you to change the value of the blinking field - the active field.



In the menus, this key allows you to access the required edit display. In the edit displays, this key allows you to select the next field (to modify it).



Any of these keys allow you to scroll the menus until you find the place you are looking for.



In an edit display, any of these keys allow you to change digits (channels, local values, etc.) or parameters (curves, ON/OFF values, etc.). A blinking field indicates that you can modify its value via the "+" and "-" keys.

This key allows you to back one item in edit displays. If you are on the first field of the screen or in a menu, this key allows you to exit one screen up.

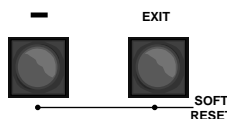

Pressing these keys simultaneously will allow you to exit the screen immediately and return to the previous display. You can leave an edit screen with several fields: you are not bound to be brought back to the first field of the screen; or to leave a screen which has no 'first' field.

This combination of keys (pressed simultaneously) allows you to reset, on each start display, default values stored in the program. These keys allow a general RESET, each time the cabinet is switched on, or after a hardware RESET.

From certain fields, this combination of keys (pressed simultaneously) allows you to access the extra display screens or edit screens.

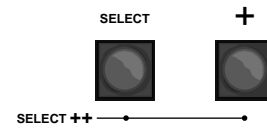

1.4. THE START MENU

The cabinet is configurable to 3 operational modes, corresponding with 3 start menus: the basic menu, the DIGI type menu and the full menu. The basic menu is the default menu, which can be maintained or you can change it for another menu of your choice. Each time the unit is switched on, it will come back to the selected menu. On the second line of the menu, a lower-case letter - b, d or f - indicates the active menu.

The basic menu allows you access to the essential functions and parameters of the unit: display of the control levels for each channel, circuit patching, flash test of the outputs at a 50% level, choice of the language (french, english) and of the start menu, and, finally, display of the information concerning the data connection, mains frequency, program version.

The DIGI type menu follows the menu of the DIGI IV/Vs units. The users of Digi IV and Vs will recognize their customary interface. They will stick to it, if the new possibilities offered by the full menu are not enough to attract them.

The full menu allows full control of the cabinet parameters, with shortcuts and access to the most specific functions, such as programming and executing sequences.

The cabinet uses a single set of parameters to manage its operations. Indeed, the menu is only giving you access - large or small - to the visualisation or the modification of the unparalleled parameters of this unit. For example, you give a channel a local level from the basic menu: the channel will keep this level even after you have changed your type of menu. Similarly, resetting the curves in one of the menus bring the curves back to their default values (Linear Light), which will be stored and used from now on.

In the following chapters you will find the description of each level of operation, meaning each menu of the cabinet.

2. THE BASIC MENU.

The basic menu bears 5 options, indicated by the digit blinking on top left of the LCD. Each time a digital or alphanumeric 'field' is blinking, it shows that you can modify its value via the "+" and "-" keys. In this manner you can scroll the menu options. Once you have chosen an option, the SELECT key loads the corresponding edit screen.

You will find below a summary of the screens to which you can access from the basic menu. They will allow you to modify the basic parameters of the cabinet and to visualize the essential information. We will describe them in detail in the following paragraphs.

See next pages.

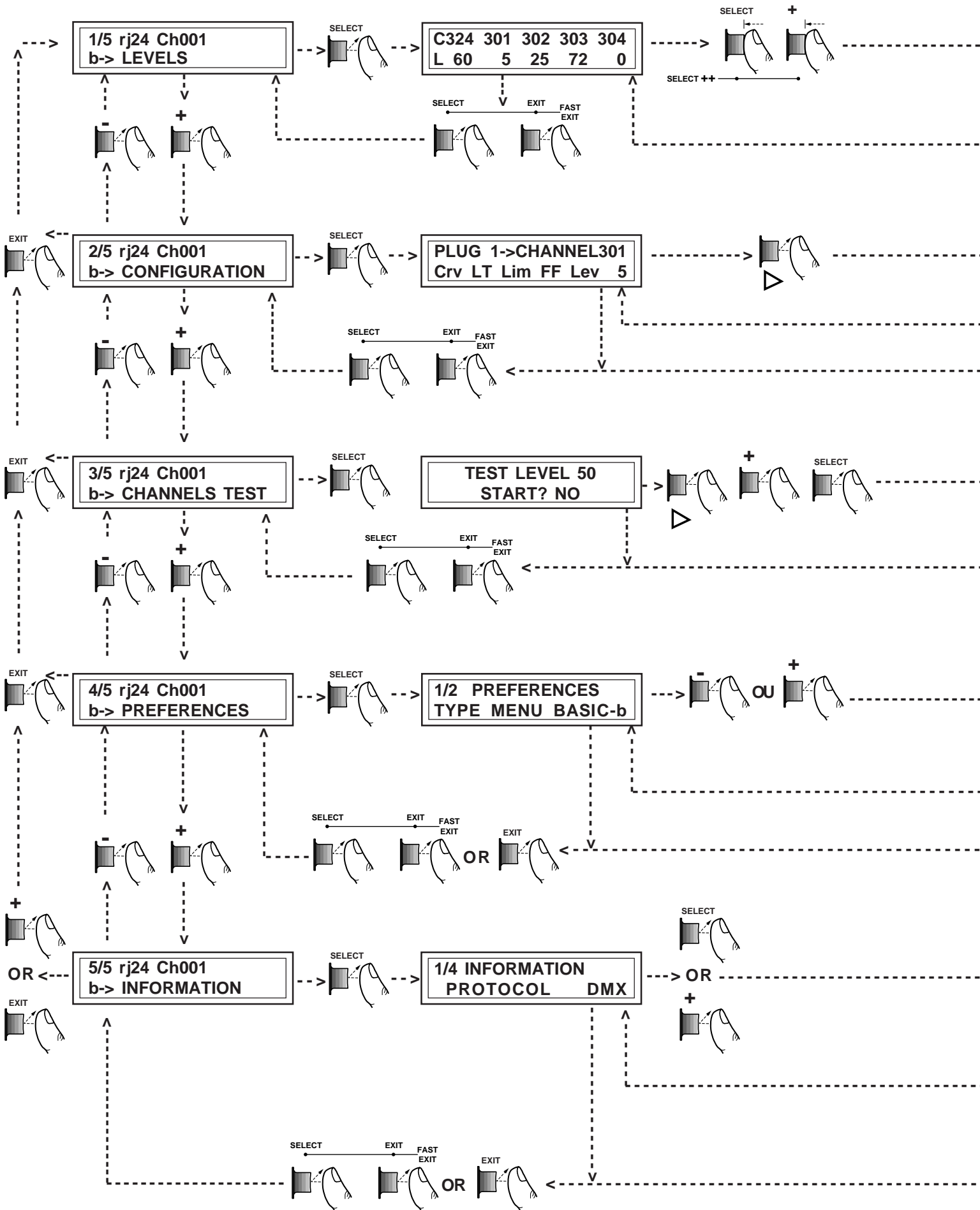

PL24	1	2	3	4
L 60	5	25	72	0

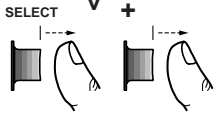

SELECT ++

Plug 1->CHANNEL301			
Num	3	Ana	5
Loc	10		

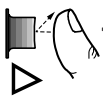

C311	312	313	314	315
T 30	50	0	0	FF

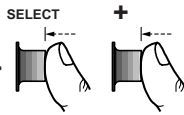

SELECT ++

PL11	12	13	14	15
T 30	50	0	0	FF

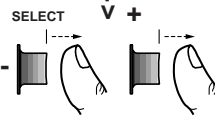

SELECT ++

2/2 PREFERENCES	
LANGUAGE ENGLISH	

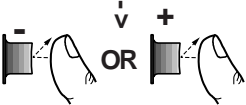

2/4 INFORMATION	
ERRORS/1000PCK	0

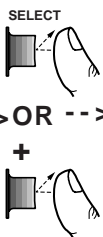

3/4 INFORMATION	
FREQUENCY	50.0Hz

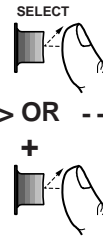

4/4 INFORMATION	
VERSION	V1-01

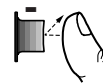
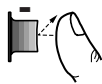
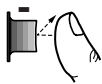

To go about the pages, you will simply follow the paths which are indicated and press the suitable keys or combination of keys. Details concerning the functions and interest of these displays will be given further.

2.1. LEVELS

This option allows you to see rapidly the control levels of each channel. If the cabinet is given different controls - digital, analog and/or local -, the highest level is executed and displayed.

Go to the LEVELS option of the basic menu. This screen is displayed when the unit is switched on or after a hard reset. To reach it from any other display, press EXIT + SELECT any number of time.

SELECT allows access to the levels display. The first line shows 5 data channels, and the second one shows the matching control levels. For example:

0% on the first channel, 30% on the second, 100% (FF) on the third. The second channel number is blinking, meaning that you can modify it to scan the 24 channels of the cabinet.

Press SELECT or "+" to step one channel forward.

Press EXIT or "-" to step one channel backward.

Press SELECT several times to lookup the levels of the other channels.

Hold down SELECT to run through the 24 channels. The display will always show the first channel (i.e. the first circuit).

Pressing EXIT, "+" and "-" will allow you similar manipulations.

Press simultaneously the SELECT and "+" keys to know which circuits match which channel: now the first line of the display will show the circuits numbers; it will be displayed on, as long as you keep holding down one of the keys.

Please note that in our specific example - channel 1 allocated to circuit 1 and no software patch - the digits showing on the first line are the same for the channels levels displays and for the circuits levels displays. Otherwise, the call for circuits levels display is very useful when the view for the channels levels display looks like the screen on the left.

While the circuits levels are displayed, hold down the "+" and "-" keys to go to the right or to the left of the screen.

Press simultaneously the EXIT and SELECT keys to revert to the start menu.

1/5 rj24 Ch001
b-> LEVELS

C 24	1	2	3	4
L 10	5	30	FF	15

C 1	2	3	4	5
L 5	30	FF	15	17

C 24	1	2	3	4
L 10	5	30	FF	15

C 4	5	6	7	8
L 15	17	0	0	FF

C 24	1	2	3	4
L 10	5	30	FF	15

PL24	1	2	3	4
L 10	5	30	FF	15

C324	301	302	303	304
L 60	5	25	72	0

C512	301	301	423	512
L 22	5	3	0	22

1/5 rj24 Ch001
b-> LEVELS

2.2. CONFIGURATION

The configuration display allows you a fast setting up of the essential parameters of the cabinet, for each output (each circuit). These parameters are as follows:

- A. The DATA channel which controls the circuit. Default values: channels 1 to 24 are respectively assigned to circuits 1 to 24.
- B. The curve for each circuit - one out of 5 curves provided for in the program: LL (Linear Light), LV (Linear Voltage), FL (Fluorescent), PA (exclusively for PAR 110V* lamps), SR (Static Relay). Default value: LL curves.
- C. The limit value for each circuit - value from 0 to 100% included - which limits proportionally the input control range. Default value: 100% (i.e. no limiting).
- D. The local value on each circuit - a control value ranging from 0 to 100% competing with the other control values (digital and/or analog): the highest instantaneous value takes precedence. Default value: 0% (i.e. no local control).

2/5 rj24 Ch001
b-> CONFIGURATION

Plug 1->Channel 1
Crv LL Lim FF Lev 5

Plug 24->Channel 24
Crv LT Lim FF Lev 10

Go to the CONFIGURATION option of the basic menu (the required key-presses are described at the beginning of this chapter).

The SELECT key accesses the edit screen for each circuit parameters. It shows the circuit number, the matching channel, the retrieval curve, the limitation and the (highest) control level.

When the number of the circuit is blinking, you can change it by pressing the "+" and "-" keys. This allows you to overview the parameters of each circuit.

Go (back) to circuit 1. Now we are willing to modify the parameters of the first circuit, starting from the channel number. Press SELECT.

Plug 1->Channel 301
Crv LL Lim FF Lev 5

The channel number is beginning to blink. Now you can modify it by pressing "+" and "-". To avoid undesirable random orderings, the channel change requires a confirmation before being processed: press the SELECT, EXIT or SELECT + EXIT keys after leaving the channel field.

Press SELECT.

Plug 1->Channel 301
Crv LT Lim FF Lev 5

The curve (LL) starts blinking. It can be changed into a LV (Linear Voltage) curve by pressing the "+" and "-" keys. The change of curve is processed at once, the light output change is immediate. To know the available curves, please go back to the beginning of this chapter.

Press SELECT.

"FF" is blinking, the limitation is 100% (no limitation). By pressing the "-" key once or more, you will be able to usher a limit value of 99%, 98%, ... 0%. An output limitation is processed at once.

*WARNING : The ROBERT JULIAT company is not responsible in any way, for lamps that are damaged in lighting units that are linked together and checked by a TIVOLI in a PAR curve.

Press “-” 5 times.

You have set up a 95% limitation on circuit 1.

```
Plug 1->Channel 301
Crv LT Lim 95 Lev 5
```

Press “+” 2 times.

You have modified this limitation to 97%.

```
Plug 1->Channel 301
Crv LT Lim 97 Lev 5
```

Press SELECT.

The second line of the mask has changed. It shows the three control values - Digital, Analog and Local - received by the circuit. It is possible to modify the local value on the unit itself, without a control desk.

```
Plug 1->Channel 301
Num 3 Ana 5 Loc 0
```

Press the “+” and “-” keys to bring circuit 1 to the local level: 10%. The modification is processed at once. Should the local level be highest among any other control (digital, analog) of the circuit, the light output will follow it.

```
Plug 1->Channel 301
Num 3 Ana 5 Loc 10
```

All parameters of circuit 1 have been modified as intended. Now we shall proceed to the second circuit. Press the EXIT key 2 times or SELECT once to return to the circuit field.

Press SELECT.

The circuit number is blinking, press the “+” key to go to the second circuit. Now you can modify the parameters of circuit 2, proceeding the way you did previously on circuit 1. Except for one difference, the channel number is no more accessible to modifications; the first channel is the one which decides of the channel numbers dedicated to the remaining circuits.

```
Plug 2->Channel 302
Crv LL Lim FF Lev 25
```

Once you are initiated to the basic manipulations you are able to modify each circuit, either following the explanations above, or proceeding on each parameter: for example, you can modify the curves, then some limitations or part of the local values.

```
Plug 3->Channel 303
Crv LL Lim FF Lev 72
```

If the parameters values of the circuits differ from their default values, a signalling character will appear on the right of the first line of the menu. For instance:

- a lower-case “c” signals that at least one circuit has a different curve from the LL (Linear Light) one, while if this letter does not show it means all the curves are “LL”;

```
2/5 rj24 Ch301 c
b-> CONFIGURATION
```

- a lower-case “m” signals at least one limitation, while if this letter does not show it means no limitation;

```
2/5 rj24 Ch301 m
b-> CONFIGURATION
```

- a lower-case “l” signals at least one local value, while if this letter does not show it means that all the local values are 0.

```
2/5 rj24 Ch301 l
b-> CONFIGURATION
```

As for the previous modifications, the menu has become:

```
2/5 rj24 Ch301 clm
b-> CONFIGURATION
```

All the parameters modifications are automatically saved and stored, even when there is a power cut.

2.3. CHANNELS TEST

TIVOLI allows the testing of each channel to a chosen level; the default test value is 50%. Accordingly, the output value will match the restitution curve and the limitation for the tested channel.

3/5 rj24 Ch301 cIm
b-> CHANNELS TEST

Go to the CHANNELS TEST option of the basic menu (the required manipulations are described at the beginning of this chapter).

TEST LEVEL 50
START? NO

The SELECT key accesses the start test display. This screen allows you to select the test value. It is also acting as a protection from manipulation errors: to carry out the test, first you have to answer YES to the question «START?».

TEST LEVEL 90
START? NO

Press the "+" or "-" keys to modify the test value. The new level will supersede the default 50% value and will be kept as test value. Press SELECT to access the next field.

TEST LEVEL 90
START? YES

Press the "+" or "-" keys if you wish to start the test.

Press SELECT.

C311	312	313	314	315
T 30	90	0	0	FF

You have just entered the test display. It looks like the LEVEL screen and it actually shows the control levels for the 5 displayed channels. As for the current channel, blinking, the displayed output value which is displayed is the highest among the existing controls input - digital, analog - and the test control. On the other hand, during the test, the local control of the current channel is momentarily suppressed; it will be restored as soon as you will leave the channel.

C312	313	314	315	316
T 50	90	0	FF	63

To test the other channels, press the "+" (or SELECT) and "-" (or EXIT) keys.

PL12	13	14	15	16
T 50	90	0	FF	63

Press simultaneously the SELECT and "+" keys to display on the first line the circuit numbers matching the channels being tested. The test per circuit display is similar to the level per circuit screen.

Pressing the SELECT + EXIT keys will bring you back to the start menu.

2.4. PREFERENCES

4/5 rj24 Ch301 cIm
b-> PREFERENCES

Go to the option PREFERENCES in the basic menu (the required manipulations are described at the beginning of this chapter).

Press SELECT to access Preferences.

You will be asked for the access code («password») which you previously set up in the full menu. It is important to remember this code and be able to key it in upon request. Do not modify preferences without reason.

PASSWORD
1427

Once you access the Preferences display, the “+” and “-” keys will allow you to scroll through.

The ‘SELECT’ key allows you to select the preference you wish to change.

1/1 MENU TYPE

By pressing the “+” or “-” keys, you can select the menu which suits you best: basic menu, full menu, or DIGI type menu. The new menu will be loaded after the menu modification is confirmed (pressing SELECT, EXIT or EXIT+SELECT). It will also become the start menu each time the unit is switched on.

1/2 PREFERENCES
TYPE MENU BASIC- b

1/2 LANGUAGE

By pressing the “+” or “-” keys, you will choose the language that the unit will ‘speak’. Once the modification of the language is confirmed (pressing SELECT, EXIT or EXIT+SELECT), the basic menu will be loaded, in the selected language. It will also become the start menu each time the unit is switched on.

1/2 UNIT PREFERENCES
LANGUAGE ENGLISH

The EXIT key (or EXIT+SELECT) will bring you back to the start menu.

2.5. INFORMATION

Go to the INFORMATION option of the basic menu (the required manipulations are described at the beginning of this chapter).

The SELECT key accesses the display showing the 4 lines of information.

1/4 PROTOCOL

The unit allows you to check the validity of the DATA transmission. Several messages could show on this line: “NO PROTOCOL”, if there is no input DATA line. If DATA is connected, the message will read, for example, “DMX 512” or “DMX 128”, indicating the nature of the protocol and the length of the packet. If there is a mistake, the message “ERR. PROTO-COLE” will show and the red error LED will light up.

5/5 rj24 Ch301 c1m
b-> INFORMATION

1/4 INFORMATION
PROTOCOL DMX 512

2/4 ERRORS /1,000PCK

Displays further information concerning the average number of erroneous packets during the DATA transmission.

2/4 INFORMATION
ERRORS/1000PCK 0

3/4 FREQUENCY

The network frequency is read when the unit is switched on and then it is used to generate the output control (triacs control).

3/4 INFORMATION
FREQUENCY 50.0Hz

4/4 VERSION

The program version of TIVOLI.

The SELECT, “+” and “-” keys will allow you to scroll through the information screen.

4/4 INFORMATION
VERSION V1-01

The EXIT (or EXIT+SELECT) key brings you back to the start menu.

2.6. SOFTWARE RESET

Pressing simultaneously the EXIT and “-” keys will allow you to access to the various software resets, on each line of the basic menu. If a password was set up in the full menu, access to the resets depends on your knowing it. Finally, you will be asked to confirm the reset, which will be followed by a completion message.

The basic menu gives you 4 different resets.

1. Levels Reset: clears local levels and, when there is no DATA connection, it clears the digital levels (when the DATA connection is off, TIVOLI retains the last valid controls for the lighting outputs).
2. Parameters Reset: the circuits parameters are given their default values again (cf subchapter 2.2).
3. Local Values Reset: clears the local levels and restores test level to 50%.
4. Preferences Reset: gives the following parameters the values as shown below.

Soft start: ON
 Booster: OFF
 Smoothing: ON
 Overvoltage: 280V
 Display: Decimal
 Access Code: 0

1/5 rj24 Ch301 clm
b-> LEVELS

Go to the LEVEL option of the basic menu.

PRESS SELECT 1s
FOR LEVELS RESET

Press EXIT + “-” to start the levels reset.
The confirmation mask will show.

LEVELS RESET
PERFORMED

Press EXIT or EXIT+SELECT to abort.
Press SELECT to carry out the reset.

1/5 rj24 Ch301 c m
b-> LEVELS

Press the EXIT key to return the start menu. The lower-case “l” is not showing any more, all the local values are cleared out.

2/5 rj24 Ch301 c m
b-> CONFIGURATION

Go to the CONFIGURATION option of the basic menu.

PRESS SELECT 1s
FOR CONFIG. RESET

Press EXIT + “-” to start the parameters reset; then follow the indications of the levels reset.

After confirmation of the reset and the menu is displaying again, the lower-case letters “c” and “m” are not showing any more, since the curves and limitation are cleared; channel 1 is affected to circuit 1.

2/5 rj24 Ch001
b-> CONFIGURATION

Go to the CHANNELS TEST option in the basic menu.
Press EXIT + “-” to start the local values reset; then follow the indications of the levels reset.

PRESS SELECT 1s
FOR LOCAL RESET

Go to the PREFERENCES or INFORMATION options in the basic menu.

PRESS SELECT 1s
FOR PREFERENCE RESET

Press EXIT + “-” to start the preferences reset; then follow the indications of the levels reset.

A lower-case "f" will show on the first line of the menu, on the right, if one of the preferences values has been changed from another menu. The preferences will return to their default levels - and the lower-case "f" will clear out - the moment the preferences reset is confirmed.

The general reset is the most powerful. It forces all the channel parameters to their default values, as well as the channels or the unit preferences, and it erases the presets, masters fields and crossfades for the show. You may access the general reset by holding together the EXIT and "-" keys while switching on the unit. If the unit is already on, just hold on the RESET HARDWARE key while pressing the EXIT and "-" keys.

After confirmation, the general reset deletes any parameters modifications stored in the block and restores the default values.

To carry out a general reset, you will be asked a passcode (if you have previously entered a locking code).

**PRESS SELECT 1s
FOR GENERAL RESET**

**GENERAL RESET
PERFORMED**

2.7. FURTHER DETAILS

If the Voltage on one of the mains phases exceeds the blocking Voltage (280V by default), the output is blocked and a warning is displaying.

The channels stay off, even if you leave this display: as a reminder, a small black square will show on the first line of the menu. Find out the reason for the overvoltage, try and put it right, then restart the unit. Refer to the full menu for additional details on the blocking voltage.

Some parameters modifications carried out in the other menus may have an effect on the displays we have described previously (refer to the full menu: here we are only indicating the differences in the display or the manipulation).

**OVERVOLTAGE
OUTPUT IS BLACK**

A. On the first line of the menu, a lower-case "p" shows the patch is ON. The configuration display of the basic menu will allow you to modify the channel numbers for each circuit.

**1/5 rj24 Ch301 p
b-> LEVELS**

B. If RENAME is ON, the displays of several screens in the basic menu will look different.

This is how the display per level screen will show:

You will notice on the display that the level of the current circuit is blinking.

**Ren8048->Pr 1->Ch301
L 60 5 25 72 0**

The CONFIGURATION screen will display as shown:

**PL 1->Ren8048->Ch301
Crv LT Lim 97 Lev 5**

This display will allow you to modify, if you wish, the name of each circuit in the same manner as you would modify the other circuits parameters. Eventually, the test per circuit screen displays as shown:

**Ren8048->PL 1->Ch301
T 60 90 25 72 0**

C. On the first line of the menu, a lower-case "f" shows on the right. It signals that one or more preferences of the list below differ from the default value. If no "f" is showing, the preferences have the default value indicated hereafter:

Soft start: ON
Booster: OFF
Smoothing: ON
Overvoltage: 280V
Display: Decimal
Access Code: 0

3. THE DIGI TYPE MENU

The DIGI type menu provides the users of the DIGI IV/Vs units with a sequence of displays to which they grew accustomed. Nevertheless the information, which used to fit the LCD surface for a 6 channels dimmer, will take up several pages. As a consequence, a menu has taken the place of the DIGI IV/Vs displays (channels, curves, local, etc.) which were the entry-points to the edit screens.

In the following sub-chapters we shall mention the displays or manipulations which differ from the DIGI IV/V screens you already know.

If you wish the Digi Box type menu as a start menu for the cabinet: go to the preferences in the other menus and change the type of the menu.

3.1. LEVELS

Entry-point: the DIGI menu, LEVELS option.

```
1/9 rj24 Ch301
d-> LEVELS
```

```
C324 301 302 303 304
L 60 5 25 72 0
```

Levels per channel screen: the first line shows 5 channels of the unit, the matching levels show on the second line.

```
PL24 1 2 3 4
L 60 5 25 72 0
```

The SELECT key (one channel forward) and EXIT key (one channel backward) will allow you access to the other channels. You will hold down the SELECT (or EXIT) key to reach the first channel.

Press simultaneously the SELECT and “+” keys to see the LEVELS per circuit screen: the first line shows the 5 circuits corresponding to the channels previously displayed.

```
Ren8048->Pr 1->Ch301
L 60 5 25 72 0
```

If the rename is ON, the screen displays differently.

```
1/9 rj24 Ch301
d-> LEVELS
```

Press the EXIT and SELECT keys to exit the levels display.

```
PRESS SELECT 1s
FOR LEVELS RESET
```

Press simultaneously the EXIT and “-” keys to perform a software reset of the local values and, in the case of no DATA connection, of the digital controls (LEVELS RESET).

3.2. CHANNELS

Entry-point: the DIGI menu, CHANNELS option.

```
2/9 rj24 Ch301
d-> CHANNELS
```

Channels patch screen: the first line shows 5 channels of the unit, the matching channels show on the second line. When the patch is OFF, you can modify the channel affected to the first circuit; you can modify any channel when the patch is ON. To avoid undesirable random output, the channel change requires a confirmation before being processed: after leaving the current field, press the SELECT, EXIT or SELECT+EXIT keys.

```
PL24 1 2 3 4
C324 301 302 303 304
```

If the rename is ON, the first line on the screen will change when you press simultaneously the SELECT and "+" keys.

```
Rename8048->Plug 1
C324 301 302 303 304
```

To exit the channels edit screen, press simultaneously the EXIT and SELECT keys.

```
PRESS SELECT 1s
FOR CHANNELS RESET
```

Press simultaneously the EXIT and "-" keys to perform a software reset of the channels (CHANNELS RESET).

3.3. CURVES

Entry-point: the DIGI menu, CURVES option.

```
3/9 rj24 Ch301
d-> CURVES
```

Curves edit screen: the first line shows 5 channels of the unit, the matching curves show on the second line.

```
C324 301 302 303 304
CrLL LV LL LL LL
```

Press simultaneously the SELECT and "+" keys to see the curves per circuit screen: the first line shows the 5 circuits matching the channels previously displayed.

```
PL24 1 2 3 4
CrLL LV LL LL LL
```

If the rename is ON, the display on the screen will show a slight difference.

```
Ren8048->PL 1->Ch301
CrLL LV LL LL LL
```

To exit the curves edit screen, press simultaneously the EXIT and SELECT keys.

```
3/9 rj24 Ch301
d-> CURVES
```

Press simultaneously the EXIT and "-" keys to perform a software reset of the curves (CURVES RESET).

```
PRESS SELECT 1s
FOR CURVES RESET
```

3.4. LOCAL CONTROLS

Entry-point: the DIGI menu, LOCALS option.

```
4/9 rj24 Ch301
d-> LOCALS
```

Local controls edit screen: the first line shows 5 channels of the unit, the matching local controls show on the second line.

```
C324 301 302 303 304
L 0 10 0 0 FF
```

Press simultaneously the SELECT and "+" keys to see the local controls per circuit screen: the first line shows the 5 circuits matching the channels previously displayed.

```
PL24 1 2 3 4
L 0 10 0 0 FF
```

If the rename is ON, the display on the screen will show a slight difference.

```
Ren8048->PL 1->Ch301
L 0 10 0 0 FF
```

To exit the local controls edit screen, press simultaneously the EXIT and SELECT keys.

```
PRESS SELECT 1s
FOR LOCAL RESET
```

Press simultaneously the EXIT and "-" keys to perform a software reset of the local controls (LOCAL RESET).

```
5/9 rj24 Ch301
d-> RENAME
```

```
RENAME OFF
```

```
RENAME ON
ARE YOU SURE ? NO
```

```
Ch324  301  302  303
R8071  8048  8049  8050
```

```
PL24   1   2   3   4
R8071  8048  8049  8050
```

```
5/9 rj24 Ch301
d-> RENAME
```

```
PRESS SELECT 1s
FOR RENAME RESET
```

```
6/9 rj24 Ch301
d-> STAGE(CONFIG.)
```

```
Plug 1 ->Channel 301
Crv LT Lim 97 Lev 10
```

```
PRESS SELECT 1s
FOR CONFIG. RESET
```

```
7/9 rj24 Ch301
d-> CHANNELS TEST
```

```
TEST LEVEL 50
START? NO
```

```
C324  301  302  303  304
T 60  50  25  72  0
```

3.5. RENAME

Entry-point: the DIGI menu, RENAME option.

The rename modification ON/OFF is followed by a confirmation message.

Rename screen: the first line shows 5 channels of the unit, the matching names show on the second line.

Press simultaneously the SELECT and "+" keys to see the rename per circuit screen: the first line shows the 5 circuits matching the channels previously displayed.

To exit the rename screen, press simultaneously the EXIT and SELECT keys.

Press simultaneously the EXIT and "-" keys to perform a software reset of the names (RENAME RESET).

3.6. STAGE (CONFIGURATION)

Entry-point: the DIGI menu, STAGE (CONFIG.) option.

All the parameters of a circuit have extended this screen: name (if rename is ON), channel, curve, limitation, control level, digital, analog and local control. Read the basic menu configuration screen for further manipulation details.

Press simultaneously the EXIT and "-" keys to perform a software reset of all the circuits parameters (CONFIG. RESET).

3.7. CHANNELS TEST

Entry-point: the DIGI menu, CHANNELS TEST option.

The starting test screen will allow you to modify the test level and, then, to confirm the starting of the test.

You will find additional details concerning the test screen while reading the relevant screen of the basic menu.

Press simultaneously the EXIT and "-" keys to perform a software reset of all the local values: all levels back to 0.

3.8. PREFERENCES

Entry-point: the DIGI menu, PREFERENCES option.

You will acknowledge the preferences: start software, patch, booster, smoothing, decimal/hex display, access code, language. A new preference: TIVOLI allows you to choose from 3 menus.

A lower-case "p" will show on the first line of the menu if the patch is ON.

Also, it will display the values of the other 6 preferences; their default values are the followings:

Soft start: ON
 Booster: OFF
 Smoothing: ON
 Over voltage (accessible from the full menu): 280V
 Display: Decimal
 Access Code: 0

A lower-case "f" will show on the first line of the menu as soon as one of the 5 accessible preferences is ascribed a value which differs from the default value.

As for the default values of the last two preferences, they are as follows:
 Language: no default value.
 Menu type: basic menu.

Press simultaneously the EXIT and "-" keys to perform a software reset of all the preferences (PREFERENCES RESET). All the preferences, except the menu type, will be forced back to their default values.

3.9. INFORMATION

Entry-point: the DIGI menu, INFORMATION option.

One additional information concerns the mains frequency. When the unit is switched on, it reads this information and then uses it to generate the output controls (triacs control).

Press simultaneously the EXIT and "-" keys to perform a software reset of all the preferences.

If the voltage on one of the mains phases overflows the blocking voltage (280V by default), the output controls are killed and a warning is displaying. The channels stay off, even if you leave this display: you will be reminded by a small black square on the first line of the menu. Find out the reason for the overvoltage, try and put it right, then restart the unit.

PRESS SELECT 1s
FOR LOCAL RESET

8/9 rj24 Ch301
d-> PREFERENCES

1/2 PREFERENCES
TYPE MENU DIGI BOX-d

8/9 rj24 Ch301 p
d-> PREFERENCES

8/9 rj24 Ch301 f
d-> PREFERENCES

PRESS SELECT 1s
FOR PREFERENCE RESET

9/9 rj24 Ch301
d-> INFO

3/4 INFORMATION
FREQUENCE 50.0Hz

PRESS SELECT 1s
FOR PREFERENCE RESET

OVERVOLTAGE
OUTPUT IS BLACK

4. THE FULL MENU

The full menu allows you access to all the facilities and parameters of TIVOLI. You are now familiar with the basic menu; you will get to know the new facilities the full menu will allow. If you are interested in the full menu, go for it; if not, stick to the basic menu for a start menu.

By selecting the type of menu in the preferences - starting from the basic menu or digi box type menu - you will access to the full menu. You will notice that the full menu is similar to the basic menu except for one additional option: the show option. A lower-case "f" (i.e. Full), at the beginning of the second line, will show the type of current menu. Let us go through these options.

4.1. LEVELS

Option similar to the one in the basic menu: initial point.

```
1/6 rj24 Ch001
f-> LEVELS
```

Levels per channels display screen.

```
C324 301 302 303 304
L 60 10 25 72 0
```

Circuits levels display.

```
PL24 1 2 3 4
L 60 10 25 72 0
```

Circuits names levels display (rename ON).

```
Ren8048->PL 1->Ch301
L 60 10 25 72 0
```

Reset local levels and digital controls levels when there is no data connection.

```
PRESS SELECT 1s
FOR LEVELS RESET
```

4.2. CONFIGURATION

This option is quite similar to the corresponding option in the basic menu, but, in addition, it offers 2 interesting manipulations:

- the group screens which allow you to dedicate a value to a group of circuits;
- the resets per parameters category.

We shall begin with a short reminder of the configuration screens. Initial point.

```
2/6 rj24 Ch001
f-> CONFIGURATION
```

Channel, curve, limitation screens.

```
Plug 1->Channel 301
Crv LV Lim 97 Lev 10
```

External controls and local level screen.

Configuration reset .

Starting from a field of parameters, the group screens can be reached by pressing simultaneously the SELECT and "+" keys. Go to the channel 3 curve and press SELECT++. Now you are able to set the limits of the group: circuits 3 to 4, circuits 3 to 24 or circuits 1 to 5. Then you will select which curve will be dedicated to the group. Warning: the current circuit will be modified even though it is not part of the group.

You reach a group screen from the limitation field.

You reach a group screen from the local value field.

When the patch is ON, you can reach a group screen via the channel field. You will notice one extra parameter in this screen:

CLEAR shows that the first circuit will receive the selected channel (403, in this example), while the others will receive channels in ascending order (404, 405 and 406);

ALL shows that all the circuits of the group (3, 4, 5 et 6, in this example) will receive the same channel (403).

Resetting one parameters category is another possibility. While the configuration reset clears out all the parameters, resetting one category affects only this one: curve, limitation, local value and channel (when the patch is ON).

For a curves reset: go to the curve field and press simultaneously the EXIT and "-" keys.

For a limitation reset: go to the limitation field and press simultaneously the EXIT and "-" keys.

For a local values reset: go to the local values field and press simultaneously the EXIT and "-" keys.

If the patch is ON, you will be able to reset the channels: go to the channel field and press simultaneously the EXIT and "-" keys.

PL 1->Ren8048->Ch301
Crv LT Lim 97 Lev 10

Plug 1-> Channel 301
Num 3 Ana 5 Loc 10

PRESS SELECT 1s
FOR CONFIG. RESET

PLUG 3 THRU 4
CURVE LV

PLUG 3 THRU 4
LIMITATION FF

PLUG 3 THRU 4
LOCAL

PLUG 3 THRU 6
CHANNEL 403 CLEAR

PLUG 3 THRU 6
CHANNEL 403 ALL

PRESS SELECT 1s
FOR CURVES RESET

PRESS SELECT 1s
FOR LIMITATION RESET

PRESS SELECT 1s
FOR LOCAL RESET

PRESS SELECT 1s
FOR CHANNELS RESET

4.3. CHANNELS TEST

```
3/6 rj24 Ch001
f-> CHANNELS TEST
```

This option is identical to the corresponding option of the basic menu: Initial point.

```
TEST LEVEL 50
START? NO
```

Test starting.

```
C324 301 302 303 304
T 60 50 25 72 0
```

Test per channel.

```
PL24 1 2 3 4
T 60 50 25 72 0
```

Test per circuit.

```
Ren8048->PL 1->Ch301
T 60 50 25 72 0
```

Test per circuit name (rename ON).

```
PRESS SELECT 1s
FOR LOCAL RESET
```

Resetting local controls and test level.

4.4. SHOW

A show is a sequence of memories.

A memory is defined by the controls levels on each output. It bears a name with letters and/or digits.

A transfer to a memory is identified with a number. It represents an evolution in time of the start levels towards the levels of the memory which is appearing - the restitution memory. It's parameters are the following:

- the fading-in time for all the outputs which level control is going up;
- the fading-out time for all the outputs which level control is going down;
- the incoming time delay in relation with the outgoing time or the other way round;
- the pause after a crossfade;
- the duration of the memory.

The transfers are linked automatically in the ascending order of their numbers. After each transfer, if the pause is OFF, the next transfer starts automatically after the duration time. If the pause is ON, the duration time lasts indefinitely; to start the next transfer, you will need to trigger the GO show control.

A show begins with a transfer going from a START setup to another setup, for instance MEMORY01. The next transfers will go - in the ascending order - from MEMORY01 to MEMORY02, from MEMORY02 to MEMORY03, etc. The last transfer in the link will go from a MEMORYXX to the memory STOP.

The unit will allow you to build up several shows and start the show you have selected.

TIVOLI allows you many other possibilities concerning the definition - and the performance - of a show. You will be introduced to these possibilities while progressing through the next paragraphs. But, previously, you will find below the tree view of show menu screens.

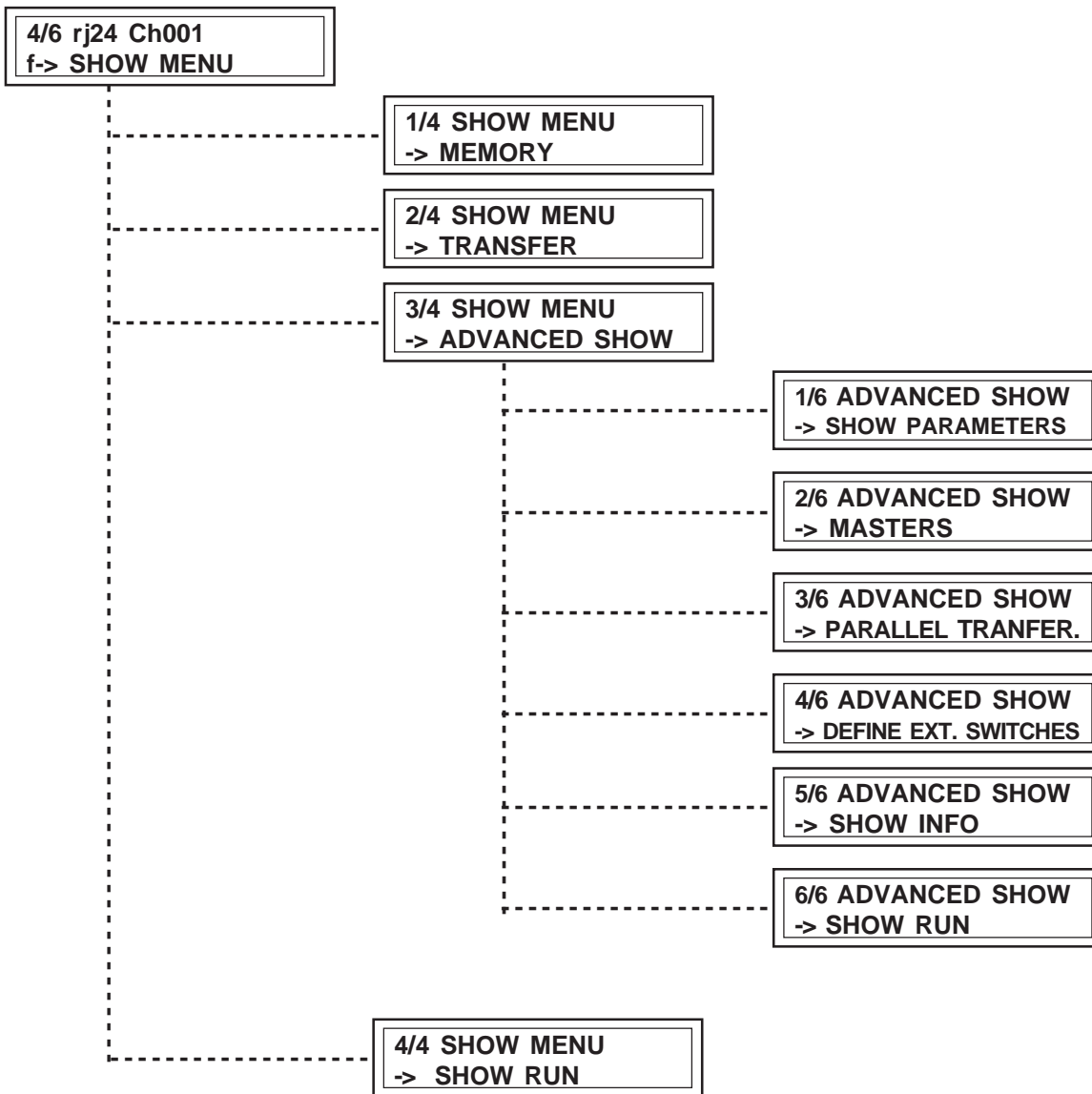

4.4.1. MEMORIES

A memory, as we explained previously, is defined by the control levels for each output.

1/4 SHOW MENU
-> MEMOIRY

A memory is called after a name made of 9 letters, digits, and/or spaces. A valid name bears at least one letter/digit - 9 spaces do not make a name. Two spaces following each other clear out the end of the name. Examples of memory names: MEMORY01, MM, 97, A, A5, 9K3Y, 4030, MA MEM, 5235.

There are 2 preset memories: START and STOP. The START memory keeps the instantaneous controls at the show startup. The STOP memory represents a black-out - all output controls at 0. You can use these 2 memories but you cannot modify them.

To create a memory, you will have to go through several steps:

1. Choose the name. We recommend you to give your memories significant names which will allow you to recognize them easily.

ADD MEM MEMORY001
0/165 REG.MEMORIES

**ADD MEM MEMORY01
ARE YOU SURE ? NO**

PL24	1	2	3	4
M 60	10	25	72	0

**ADD MEMORY001 OK
EDIT TIME ? YES**

**MODIFY MEM MEMORY006
9/165 REG.MEMORIES.**

**DELETE MEM MEMORY004
9/165 REG.MEMORIES**

**COPY MEM MEMORY004
INTO MEM ALPHA**

**INSERT MEM LEFT
BEFORE MEM ALPHA**

A

**MEMORY004 EXISTS
OVERWRITE IT ? NO**

**START EXISTS
CHOOSE ANOTHER NAME**

2. Confirm the action.

3. Define its control levels. When it is created, the memory picks up the output levels. Then, in local mode, you can modify the memory levels. Using a digital or analog desk linked to the cabinet will be a fast method for setting levels and creating a memory.

4. A new memory creates automatically a transfer with default transfer times; you can keep them or modify them, as you wish.

You can work five different actions with the memories:

- Creating: we have been through this previously.

- Modifying an existing memory: to choose it, scroll through all the names of memories already defined. Then, the memory will modify its levels in accordance with the output levels.

- Clear a memory: at the same time, you will clear the incoming transfer(s) to this memory.

- Copy a memory in another memory.

- Insert a memory: while a creation or a copy adds the new memory to the end of the memories already defined (i.e. it generates a transfer at the end of the defined transfers), the insertion allows you to choose the place for this memory.

All the above actions or part of these actions are accessible according to the amount of stored memories in relation with the available space. As an example, after a show reset, the number of defined memories is 0, and all you can do is creating memories; once you have created the maximum number of memories, you can only modify or clear.

Apart from the messages confirming the creation or clearance of a memory, other messages are liable to display following your actions.

All your actions on the memories are duplicating on the matching transfers. Modifying the preset times will effectively modify the transfer times for the (first) ingoing transfer time to this memory. This trick will allow you to perform your show without modifying directly the transfers. But if you wish to work with the transfers, you just read the next paragraph.

4.4.2. CROSSFADES

As soon as there exists at least one transfer, you will be given access to the crossfades. The transfers are automatically generated when a preset is created. As a result, after the 4 presets MEMORY01, MEMORY02, MEMORY03 et MEMORY04 have been notified (in this order), 5 crossfades are linked: START->MEMORY01, MEMORY01->MEMORY02, MEMORY02->MEMORY03, MEMORY03->MEMORY04 and MEMORY04->STOP. This link of 5 memories makes up your show and, now, you can start it.

- The reason for working on the crossfades is to modify this automatic link:
- to use the same memory in several crossfades - with different fading times;
 - to modify the coming out order of the memories;

- to create several sequences (crossfades 1-5; crossfades 6-29; crossfades 40-50) to be started by selection (please refer to «start the show» and «show parameters»).

Before declaring new transfers or a new sequence, let us examine closely the sequence which has been automatically built up after setting up 4 presets. The 'modify crossfade' option will help us and we can run through the 5 fades which bear the numbers 1 to 5.

Each crossfade starts from the preset retrieved by the previous memory - or it starts from the START memory, if this is the first preset of a sequence. The fade is accomplished towards a memory and following times to which you can refer and/or modify. You will also note the lighting output during the modification of the fade.

We are dealing with a crossfade between two presets - as the display is showing - one preset is outgoing, the other one is ingoing. More precisely - like we did at the beginning of sub-chapter 4.4. - the fade starts from the immediate output levels. These levels do not necessarily coincide with the levels of the outgoing preset: other outgoing memories or masters in independently-timed fades are liable to pile up. Knowing this, we shall keep the term of «crossfade between two memories».

The first crossfade takes place between the START memory and the restitution memory of the fade. It is the only fade through which the sequence can be started and, at the same time, it acts as the identification of the sequence (read also «Show parameters, first fade»).

The last fade, to the STOP memory, which the program adds automatically, helps punctuating the end of a sequence. As you will see in the case of a loop execution of the sequence, this last fade is not executed. But it represents the very end of the sequence, which is an essential information when several sequences are declared.

Each time you will declare a fade to the STOP memory, this fade will close a sequence. If other crossfades are following, they will build another (a new) sequence. Declaring then, in the middle of a sequence, a fading to the STOP memory will divide this sequence into 2 independant sequences. One reverse modification can concatenate (link) 2 consecutive sequences.

You can operate the crossfades in five different manners:

- Modify a crossfade: see above.
 - Clear a crossfade: the crossfade memory is retained, it is not cleared; the following crossfades are shifted.

- Create a crossfade: you will declare a fade towards an existing memory, either at the end of the last show, either further on, to start a new show.

- Copy of a group of fades towards a fade number.

- Insert a fade: you declare a fade towards an existing memory; the following crossfades are shifted.

**2/4 SHOW MENU
-> TRANSFER**

**MODIFY TRANS 5/ 10
MEMORY004->MEMORY005**

**DELETE TRANS 6/ 10
MEMORY005->MEMORY006**

**ADD TRANS 10/ 10
MEMORY009->STOP**

**COPY TR. 6TILL 10
TO TRANSFER 100**

**TR. 6- 10 ->100-104
DONE**

**INSERT TRANS 102/104
MEMORY006->ALPHA**

During all these actions, the program will help you. For instance, it will try to protect the last memory of a sequence against being cleared or it will try to avoid dangerous copies. But you will be entirely free to - and responsible for - defining your sequence(s). Also you shall pay attention to the outgoing time of the first fade which runs the outgoing time of the START memory.

4.4.3. SHOW EXECUTION

4/4 SHOW MENU
-> **SHOW RUN**

6/6 ADVANCED SHOW
-> **SHOW RUN**

r MEMORY001 ^ 0:04
p MEMORY002 Tr 002

You can start the show from 2 equal starting points: the last option of the show menu or of the show plus menu. They will allow you a fast access to the show starting, whatever your last edit action.

During the running of a show started in local mode, the first line will display the following information:

- "r" for restitution;
- the name of the retrieving memory;
- the retrieval step, symbolized by : "<" for wait, "^" for increase, "=" for maintain, "P" for pause;
- the time as a countdown.

On the second line, you will read:

- "p" for preparation;
- the name of the memory on preparation;
- the fade in preparation.

As soon as you reach this display, you are able to control the running of the show, using the 4 keys of the keyboard or the controls of an analog or digital control desk - the faders or the flash keys. With your Espion control, you will easily take the matching channels from 0% to FF. In the chart below, you will find all the show controls.

If the cabinet is off during the running of the show, it will start again from

Show Command	Keys entry	Analog entry	Digital entry
GO	SEL	Entry 1	1st Channel
PAUSE	«-» (minus)	Entry 2	2nd Channel
1 STEP FORWARD	«+» and EXIT	Entry 3	3rd Channel
1 STEP BACKWARD	«-» and EXIT	Entry 4	4th Channel
GO TO 0	«+» (plus)	Entry 5	5th Channel
PANIC	EXIT and SEL	Entry 6	6th Channel
NEXT SEQUENCE	SEL and «+»	Entry 7	7th Channel
EXIT	EXIT 1second		

the first fade of the current sequence when the unit is powered up.

Using an external keyboard is another possibility for starting the show. You will read more in paragraph 4.4.8.

4.4.4. SHOW PLUS MENU

This menu gathers the most powerful possibilities of the show: you will get to know them in the next paragraphs.

3/4 SHOW MENU
-> **ADVANCED**

4.4.5. SHOW PARAMETERS

For each of the show parameters we are going to describe its interest and default value.

1/6 ADVANCED SHOW
-> **SHOW PARAMETERS**

When the unit is switched on, there are 3 possibilities to start the show:

- the manual start (MANUAL): to start the show, you will retrace your steps from the start menu to the «start the show» option of the show menu;
- the automatic start (AUTO): when the unit is switched on, the execution show screen is displayed and the show begins;
- the panic start (PANIC): the unit always positions itself on the execution show screen and it retrieves the 'panic' output levels while waiting for a user's control.

1/9 SHOW PARAMETERS
START MANUAL

If TIVOLI is switched off during the running of a show, the next time it is switched on the unit will start anew from the beginning.

Default value on show start-up: manual.

The 'first fade' parameter represents the first fade to be run when a show is starting.

2/9 SHOW PARAMETERS
FIRST TRANSFER 1

When several sequences are defined in the unit, you can select a sequence from its first fade. The "+" key looks up a begin the sequence fade and displays it. The "-" key jumps back to the first fade of the first sequence.

If you clear the first fade from the current sequence or if you displace it in the fades edit screen, the first fade to be set is not automatically updated and you will be surprised when you start the show. But, it will be updated via the first fade field.

The variable will eventually keep the last value, generated from the show control 'GO TO THE NEXT SEQUENCE' given in the course of the show execution.

The Repetition parameter controls the end of the show. When its value is OFF, the show will stop at the end of the last crossfade - usually, a fade to the STOP memory. When its value is ON - its default value - the first fade takes for the fade to STOP, so that the show skips the fade to black-out (STOP) and starts again from the beginning.

3/9 SHOW PARAMETERS
REPETITION ON

**4/9 SHOW PARAMETERS
DEF. TIME UP 0:10**

**5/9 SHOW PARAMETERS
DEF.TIME DOWN 0:10**

**6/9 SHOW PARAMETERS
DEFAULT BREAK OFF**

**7/9 SHOW PARAMETERS
DEF.HOLD TIME 0:00**

**8/9 SHOW PARAMETERS
TENTH ACCESS T< 0:10**

**9/9 SHOW PARAMETERS
PANIC LEVEL 30**

**2/6 ADVANCED SHOW
-> MASTERS**

**ADD MS 9GAMMA
2/155 REG.MASTERS**

**ADD MS 9GAMMA
ARE YOU SURE ? YES**

PL24	1	2	3	4
M 23	60	60	0	60

**3/6 ADVANCED SHOW
-> PARALLEL TRANSFER**

**TRANSFER 1
START -> MEMORY001**

**TRANSFER 1
ADD SUBTR. 01/00**

The default crossfade times parameters help initialize a new crossfade. These 4 parameters will help you select you own default crossfade values.

Having at your disposal a one-tenth of second accuracy may be useful, specially when dealing with short fade times, under 10s. But when you are dealing with longer times, it can be very irritating to go through the 10th of seconds fields just for adding a '0'; consequently, the program will skip it automatically. You can thus declare times from 0.1 sec to 9.9 sec, then you will declare 10 sec, 11, 12, etc.

If this 10 seconds limit does not suit you, you can change it. Concerning the extreme values: 0 time will bar access to the tenths of seconds, 50 minutes will always allow it.

The panic level parameter is the only level sent through the 'panic' show control, for all the outputs. Default value: 30%.

4.4.6. MASTERS

The masters, as well as the memories, are defined by the control levels for each output.

Their names are composed of up to 9 letters, digits or spaces. Giving them specific names will mark the difference between memories and masters. For instance, the names of your masters will always begin with a digit or the letters X,Y,Z.

The masters edit displays look like the memories edit displays, but there is one difference: no time can be set to a master. The fade times will be defined when you build the independently-timed fades and when you declare the external keys, as will be seen in the next 2 paragraphs.

4.4.7. INDEPENDENTLY-TIMED FADES

We know that a sequence is a series of crossfades: the main crossfades. In this sequence, you can insert independant light movements, which will be carried out in parallel with the main crossfades: these are the independently-timed fades.

A independently-timed fade is defined by the followings:

- the main crossfade of the show;
- his subfade number, comprised between 1 and 13, in which 13 is the maximum number of independently-timed fades. This number is automatically assigned during the creation of a independently-timed fade, and modified during its clearing;

- the related master;
- the delay time between its beginning and the beginning of the main crossfade;
- the ingoing time of the master, i.e. the required time for the significant levels (above zero) of the master to be reached up or down;
- the duration of the significant levels of the master;
- the fading out time, during which the significant levels of the master fade down to 0;

You can create, modify and delete a independently-timed fade. A confirmation signal will show before the edit of a independently-timed fade which will be followed by an accomplishment message.

The default values for the ingoing, duration and outgoing times, are respectively the ingoing, duration and outgoing times for the show. To know the number of independently-timed fades for each crossfade, go to the number of the main crossfade in the subtransfers edit mask and scan it.

The maximal number of parallel effects (main crossfades included) is 15. Some precisions concerning a main crossfade edit:

1. Deleting a main crossfade will clear out all the related independently-timed fades.
2. Shifting main crossfades - by deleting or inserting a crossfade - will obviously maintain the existing links between the main crossfades and the related independently-timed fades.
3. Copying a group of crossfades will only copy the main crossfades: you will have to create new independently-timed fades for the new group.

4.4.8. EXTERNAL SWITCHES

Concerning the hardware, the external switches are 15 flash contacts on the wires 1-15 of the female SUB D25 socket; the 16th button, located on wire 16, is an ON/OFF button.

When button 16 switches ON, the external switches are controlling the cabinet and the corresponding screen is displaying.

But before, activate the buttons, we ought to define them. Setting back button 16 to OFF will give you back the control of the unit.

Defining an external switch means assigning it a master, an ingoing time and an outgoing time for the levels which are controlled by the master. The times are defined with an one second accuracy.

SUBTRANSFER 1-01
MASTER 9GAMMA

SUBTRANSFER 1-01
DELAY 0:00.0

SUBTRANSFER 1-01
APP. TIME 0:10.0

SUBTRANSFER 1-01
HOLD TIME 0:00.0

SUBTRANSFER 1-01
DISAPP.TIME 0:10.0

TRANSFER 1
ARE YOU SURE ? YES

ADD SUBTRANSFER
1-01 DONE

TRANSFER 1
ADD SUBTR. 01/00

0 ACTIVE SHITCHES
MASTER

4/6 ADVANCED SHOW
->DEFINE EXT.SWITCHS

EXTERNAL SWITCH 1
MASTER 9GAMMA

EXTERNAL SWITCH 1
APP. TIME 0:12

EXTERNAL SWITCH 1
DISAPP.TIME 0:03

**3 ACTIVE SWITCHES
MASTER ^ 9GAMMA**

You defined 5 buttons. Bring button 16 back to ON and press 3 of the 5 defined switches. The display on the external switches screen will show differently.

**EXTERNAL SWITCH 15
MASTER NEXT SEQ**

This control screen will allow you to run through all the active masters; the signs showing on the second line are: “^” meaning going up, “=” meaning unchanged, and “v” meaning going down.

The external switches will also allow you to start a show and control it. You only have to link the buttons to the show controls. These controls are still called “masters” but you will note 2 differences with the proper masters:

- the show control masters have no ingoing or outgoing time - if you push the switch, the command starts at once;
- these are submaster controls, thus they do not show on the external keys screen.

The next external keys will be linked to the show controls (see also the 4.4.3 paragraph):

Switch #	Show control
9	GO
10	PAUSE
11	STEP FORW
12	STEP BACK
13	GO TO 0
14	PANIC
15	NEXT SEQ
16 OFF	EXIT

There are 3 possibilities for using the external keys:

1. Controlling masters: we advise you to delete the 9-15 controls or put “real” masters in their place.
2. Controllin a show: you can keep the default controls, double them, get rid of some of them (PANIC or NEXT SEQ, for example).
3. Controlling both masters and show; by mixing up, in real-time, the running of the show and masters outputs, you will be free to use the full power and richness of the lighting outputs allowed by TIVOLI.

**5/6 ADVANCED SHOW
-> SHOW INFORMATION**

4.4.9. INFO SHOW

The info show will give you a summary with the number of show elements (memories, masters and crossfades) that you have defined, as well as the available space for each element.

**1/4 SHOW INFO
MEMORIES 10/160**

**2/4 SHOW INFO
MASTERS 5/155**

**3/4 SHOW INFO
TRANSFERS 11/250**

Memories and masters share a common space of 165 steps. Recording a memory reduces the available memory space as well as the masters space; and conversely. Likewise, the (main) crossfades and the independently-timed fades share a common space of 256 steps.

**4/4 SHOW INFO
PARALLEL TR. 6/245**

4.5. PREFERENCES

You will now read the tree structure of the screens which will run down from the PREFERENCES MENU of the full menu.

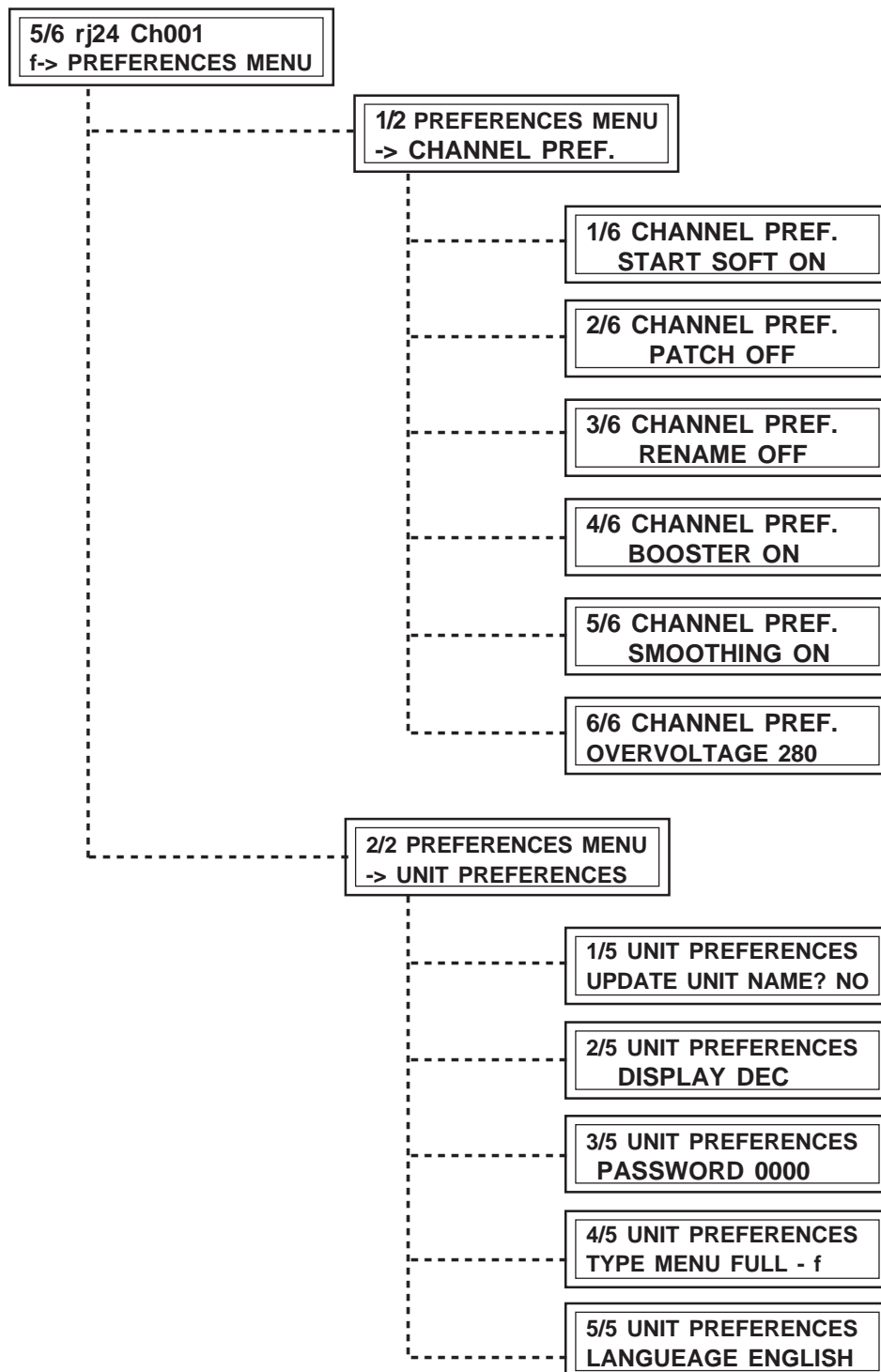

Further on, you will read the details on the channel preferences and the unit preferences.

4.5.1 CHANNEL PREFERENCES

1/2 PREFERENCES MENU
->CHANNEL PREFERENCE

You will find a brief description of the preferences gathered under the name channel preferences, as well as their default values.

1/6 CHANNEL PEF.
START SOFT ON

The start soft preference performs a slow start of the unit to reach the external controls values, thus avoiding a sudden consumption on the electric network. The time-out lasts about 2 seconds.

Warning: During a show, the Start Soft option is inactive. You are free to choose - and are responsible for selecting - the levels and the times for the first fade, as well as the 'panic' level.

Default value: Start soft ON.

2/6 CHANNEL PEF.
PATCH OFF

When the soft patch is ON, you are allowed to select which channel will control which output without respect to the ascending order set by the patch OFF. You can control several outputs - even the 24 of them! - with a single channel. After the modification of the patch ON<->OFF, you will be asked a confirmation. Go back to the configuration to set the control channels.

Default value: Patch OFF.

3/6 CHANNEL PEF.
RENAME OFF

Renumbering the channels will allow, for example, matching the desk numbers with the dimmers numbers. You have already noticed that some of the displays look different when this option is active (rename ON).

Default value: Rename OFF.

4/6 CHANNEL PEF.
BOOSTER ON

By allowing the separation of the DATA IN and DATA OUT lines, the booster ensures a highly reliable wiring. When the booster value is ON, the DATA OUT line transforms into a transmitter which retrofits the logical levels but does not reformat the signal. When the booster is disabled (OFF), the Data line is continuous: the input signal is sent to the output. As soon as the cabinet is powered off, the booster is automatically shorted out, which ensures, under any condition, the continuity of the Data line.

Default value: Booster OFF.

5/6 CHANNEL PEF.
SMOOTHING ON

Smoothing increases the resolution of the digital control, from 256 steps to 7,500, by interpolation. When the smoothing is OFF, the 256 steps digital control becomes directly an output control.

Default value: Smoothing ON.

OVERVOLTAGE
OUTPUT IS BLACK

If the voltage on one of the phases of the network overflows the blocking voltage (280V by default), the output controls are barred and a warning is displayed.

Even if you leave this screen, the channels stay off: on the first line of the menu, a little black square will be a reminder. Find out the reason for the overvoltage, try and put it right, then restart the unit (hardware Reset).

6/6 CHANNEL PEF.
OVERVOLTAGE 280

You can assign the blocking voltage a value comprised between 110V and 440V. Too low a voltage might engage an unnecessary blocking of the outputs; too high a voltage removes any protection.

Default value: blocking Voltage 280V.

4.5.2 UNIT PREFERENCES

You will find below a short description of the unit preferences together with their default values.

You can give your cabinet a name; you will use 20 characters, letters, digits or spaces. Two successive spaces delete the end of the name.
Default value for the name of the unit: TIVOLI

All the control values are displayed as decimal, or, to be precise, in percentage related to the maximal 255 steps value. You can use the hexadecimal display to obtain a better display precision and to view all the control steps issued by your desk. As an appendix, you will find a decimal/hex conversion table.

The display mode, decimal or hexadecimal, does not alter the precision of the controls received and executed by the cabinet.
Default value: DECimal display.

An access word, different from 0, bars the preferences access to an unauthorised user, so that he is forbidden to modify the type of menu. Without this access code, resetting is not allowed either. On the other hand, it is possible to change the channel parameters or access to the display screens.

Evidently a 4 digits code is not infallible; but it will always allow you a 99% protection.

If you lose or forget the access code, TIVOLI is fitted with a built-in "rj" password, equal to the number 'pi' by 1,000, that is to say 3,142; enter three times this code to unlock the unit.

Default value: 0000, no protection against unauthorised manipulations.

Menu type: you can choose the start menu in the basic menu, the full menu and the digi box type menu.

Default value (after a general reset): basic menu.

Language: you can choose between french and english.

Default value: no default value, the last choice is maintained.

2/2 PREFERENCES MENU
-> UNIT PREFERENCES

1/5 UNIT PREFERENCES
UPDATE UNIT NAME?NO

UNIT NAME
TIVOLI

2/5 UNIT PREFERENCES
DISPLAY DEC

3/5 UNIT PREFERENCES
PASSWORD 0000

4/5 UNIT PREFERENCES
TYPE MENU FULL- f

5/5 UNIT PREFERENCES
LANGUAGE ENGLISH

4.6. UNIT TEST & INFO

You will now read the tree structure of the screens which will run down from the UNIT TEST & INFO MENU of the full menu.

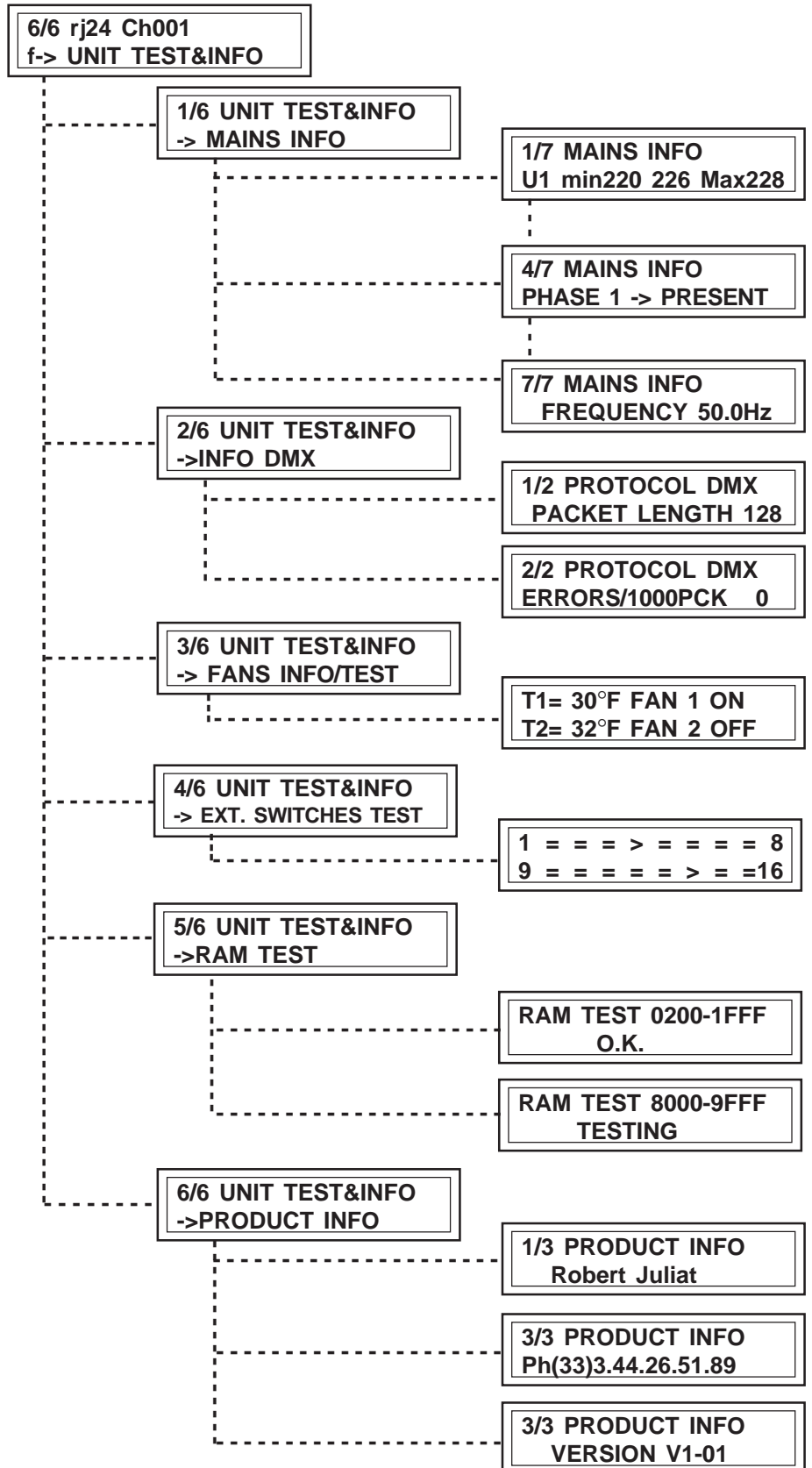

The unit is permanently surveying the electric network. The mains information gives a report on the 3 phases and on the mains frequency. The mains voltage is read and displayed in real-time for each phase; the minimal and maximal values are saved from the moment the cabinet is switched on. You should not take the displayed levels as accurate values, for the cabinet is not a voltmeter; these values give an information on the condition and the evolution of the voltage per phase.

The presence of the phases is also displayed. The cabinet can go on working when 2 phases are missing but, then, it cannot be started.

The network frequency is the instant frequency which is read when the unit is powered up and which is used during the power sequencing to generate the output controls (the triacs controls).

The information concerning the sequencing link are the following:

- the type of protocol: DMX, NONE or ERR. (when error, the red LED lights up);
- the length of protocol: when the length of the packet is changing, the longest value is displayed;
- the average error number for 1,000 packets.

The FANS INFO/TEST option displays the temperatures read by the 2 temperature sensors and it tests the functioning of the fans. The rotation speed of each fan is controlled by the corresponding sensor, after 5 temperature levels.

The temperature displays in degrees Celsius or Fahrenheit, according to the selected language. Each fan can be tested in the ON or OFF position; if the temperature overruns the last level, you cannot force the fan to stop. When you exit the test, the fans go back to their rotation speeds controlled by the sensors.

You can test swiftly the 16 external switches.

On each line you will see the condition of the 8 switches: 1 to 8 and 9 to 16. For each switch, "=" means open contact, ">" means closed contact.

You are testing the 2 RAMs which outfit the unit.

1/6 UNIT TEST&INFO
-> MAINS INFO

1/7 MAINS INFO
U1 min220 226 Max228

4/7 MAINS INFO
PHASE 1 -> PRESENT

7/7 MAINS INFO
FREQUENCY 50.0Hz

2/6 TEST&INFO UNITE
->INFO DMX

1/2 PROTOCOL DMX
PACKET LENGTH 128

2/2 PROTOCOL DMX
ERRORS/1000PCK 0

3/6 UNIT TEST&INFO
-> FANS INFO/TEST

T1= 86°F VENT. 1 ON
T2= 90°F VENT. 2 OFF

4/6 UNIT TEST&INFO
-> EXT. SWITCHES TEST

1 = = = > = = = 8
9 = = = = = > = = 16

5/6 UNIT TEST&INFO
-> RAM TEST

RAM TEST 0200-1FFF
O.K.

RAM TEST 8000-9FFF
TESTING

6/6 UNIT TEST&INFO
->PRODUCT INFO

1/3 PRODUCT INFO
Robert Juliat

3/3 PRODUCT INFO
Ph.(33)3.44.26.51.89

3/3 PRODUCT INFO
VERSION V1-01

Among the information concerning the product, you will find the name of the manufacturer, his phone number and the version number of the TIVOLI program.

4.7. SOFTWARE RESET

A software reset forces the affected parameters to their default values. By pressing together the EXIT and “-” keys you can start a software reset from several places.

In the full menu, the options which are similar to the basic menu options generate the same resets than those which are described in the subchapter 2.7.

In the configuration screen, the resets per parameter class are described in sub-chapter 4.2.

Reset	Concerned parameters	Menu	Option
Memories	Mémoires & transferts	Show	MEMORY
Transfer	Transferts	Show	TRANSFER
Show	Mémoires, masters, transferts, paramètres	Show	SHOW MENU
		Show	RUN SHOW
		Advanced show	SHOW INFO
		Advanced show	RUN SHOW
Show parameters	Show parameters	Advanced show	SHOW PARAMETERS
Masters	Masters, ext. switches, parallel transfers	Advanced show	MEMORY
Parallel Tr.	Parallel transfers	Advanced show	TRANSFER
Ext. switches	External switches	Advanced show	MEMORY

5. APPENDIX

Les pas DMX/ DMX steps.	Décimal (%).	Hexadécimal.
0	0	00
1	0	01
2	1	02
3	1	03
4	2	04
5	2	05
6	2	06
7	3	07
8	3	08
9	4	09
10	4	0A
11	4	0b
12	5	0C
13	5	0d
14	5	0E
15	6	0F
16	6	10
17	7	11
18	7	12
19	7	13
20	8	14
21	8	15
22	9	16
23	9	17
24	9	18
25	10	19
26	10	1A
27	11	1b
28	11	1C
29	11	1d
30	12	1E
31	12	1F

Les pas DMX/ DMX steps.	Décimal (%).	Hexadécimal.
32	13	20
33	13	21
34	13	22
35	14	23
36	14	24
37	15	25
38	15	26
39	15	27
40	16	28
41	16	29
42	16	2A
43	17	2b
44	17	2C
45	18	2d
46	18	2E
47	18	2F
48	19	30
49	19	31
50	20	32
51	20	33
52	20	34
53	21	35
54	21	36
55	22	37
56	22	38
57	22	39
58	23	3A
59	23	3b
60	24	3C
61	24	3d
62	24	3E
63	25	3F

Les pas DMX/ DMX steps.	Décimal (%).	Hexadécimal.
64	25	40
65	25	41
66	26	42
67	26	43
68	27	44
69	27	45
70	27	46
71	28	47
72	28	48
73	29	49
74	29	4A
75	29	4b
76	30	4C
77	30	4d
78	31	4E
79	31	4F
80	31	50
81	32	51
82	32	52
83	33	53
84	33	54
85	33	55
86	34	56
87	34	57
88	35	58
89	35	59
90	35	5A
91	36	5b
92	36	5C
93	36	5d
94	37	5E
95	37	5F

Les pas DMX/ DMX steps.	Décimal (%).	Hexadécimal.
96	38	60
97	38	61
98	38	62
99	39	63
100	39	64
101	40	65
102	40	66
103	40	67
104	41	68
105	41	69
106	42	6A
107	42	6b
108	42	6C
109	43	6d
110	43	6E
111	44	6F
112	44	70
113	44	71
114	45	72
115	45	73
116	45	74
117	46	75
118	46	76
119	47	77
120	47	78
121	47	79
122	48	7A
123	48	7b
124	49	7C
125	49	7d
126	49	7E
127	50	7F

Les pas DMX/ DMX steps.	Décimal (%).	Hexadécimal.
128	50	80
129	51	81
130	51	82
131	51	83
132	52	84
133	52	85
134	53	86
135	53	87
136	53	88
137	54	89
138	54	8A
139	55	8b
140	55	8C
141	55	8d
142	56	8E
143	56	8F
144	56	90
145	57	91
146	57	92
147	58	93
148	58	94
149	58	95
150	59	96
151	59	97
152	60	98
153	60	99
154	60	9A
155	61	9b
156	61	9C
157	62	9d
158	62	9E
159	62	9F

Les pas DMX/ DMX steps.	Décimal (%).	Hexadécimal.
160	63	A0
161	63	A1
162	64	A2
163	64	A3
164	64	A4
165	65	A5
166	65	A6
167	65	A7
168	66	A8
169	66	A9
170	67	AA
171	67	Ab
172	67	AC
173	68	Ad
174	68	AE
175	69	AF
176	69	b0
177	69	b1
178	70	b2
179	70	b3
180	71	b4
181	71	b5
182	71	b6
183	72	b7
184	72	b8
185	73	b9
186	73	bA
187	73	bb
188	74	bC
189	74	bd
190	75	bE
191	75	bF

Les pas DMX/ DMX steps.	Décimal (%).	Hexadécimal.
192	75	C0
193	76	C1
194	76	C2
195	76	C3
196	77	C4
197	77	C5
198	78	C6
199	78	C7
200	78	C8
201	79	C9
202	79	CA
203	80	Cb
204	80	CC
205	80	Cd
206	81	CE
207	81	CF
208	82	d0
209	82	d1
210	82	d2
211	83	d3
212	83	d4
213	84	d5
214	84	d6
215	84	d7
216	85	d8
217	85	d9
218	85	dA
219	86	db
220	86	dC
221	87	dd
222	87	dE
223	87	dF

Les pas DMX/ DMX steps.	Décimal (%).	Hexadécimal.
224	88	E0
225	88	E1
226	89	E2
227	89	E3
228	89	E4
229	90	E5
230	90	E6
231	91	E7
232	91	E8
233	91	E9
234	92	EA
235	92	Eb
236	93	EC
237	93	Ed
238	93	EE
239	94	EF
240	94	F0
241	95	F1
242	95	F2
243	95	F3
244	96	F4
245	96	F5
246	96	F6
247	97	F7
248	97	F8
249	98	F9
250	98	FA
251	98	Fb
252	99	FC
253	99	Fd
254	FF (100%)	FE
255	FF (100%)	FF

XLR 5 WIRING DATA	
Rep	STANDARD DMX 512
1	0V.
2	DATA 1-
3	DATA 1+
4	NOT USED
5	NOT USED

ANALOG. 0/+10V WIRING	
1 to 24	: Ch.
25	: 0V.

EXTERNAL CONTROLS WIRING	
1 à 15	: SWITCHES
16	: ON/OFF
17 - 25	: 0V

NOTES